

*Murray*<sup>®</sup>

# DOMINATOR

We strive to ensure that our products are of the highest quality and free of manufacturing defects or missing parts. However, if you have any problems with your new product, **DO NOT RETURN IT TO THE STORE**, please contact us toll free @:

1-866-556-2757

FAX: 1-866-873-3532

[pooltables@escaladesports.com](mailto:pooltables@escaladesports.com)

Or write to:  
Escalade Sports  
Customer Service Department  
P.O. Box 889  
Evansville IN 47706

Please have your model number when inquiring about parts.

When contacting Escalade Sports please provide your model number, serial number (if applicable), and part number if requesting a replacement part. These numbers are located on the product, packaging, and in this owners manual.

Your Model Number           **P3236**

**IMPORTANT! READ THIS MANUAL ALL THE WAY THROUGH BEFORE BEGINNING TO PUT YOUR GAME TABLE TOGETHER! THEN READ EACH STEP BEFORE STARTING THAT STEP.**

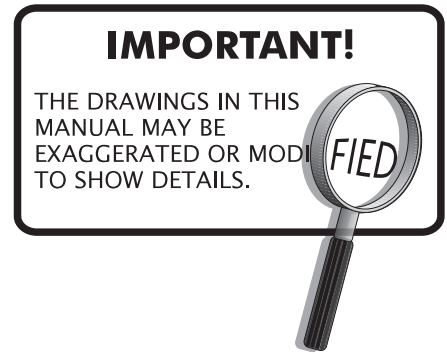

## TWO ADULTS ARE REQUIRED TO ASSEMBLE THIS GAME TABLE

### Tools Required:

Philips Screwdriver  
Standard Screwdriver  
Furniture Polish and Cloth  
Putty Knife  
Tape Measure

Sanding Block  
Awl or 8d Nail  
Scissors or Sharp Knife  
Carpenters Level

**An electric screwdriver is helpful in assembly. However, please set at low torque and use extreme caution with an electric screwdriver because you could overtighten the hardware and strip the screws.**

### Notes:

Make sure you understand the following tips before you begin to assemble your pool table.

1. When installing parts that have more than one bolt, start **ALL** the bolts in that part by hand before tightening anything.
2. Some drawings or images in this manual may not look exactly like your product. Please read and understand the text before starting each assembly step.
3. The table adds weight to any floor. Be sure the floor can withstand this kind of weight. If the floor sags, table will be impossible to level.



### **WARNING:**

**READ AND FOLLOW ALL ASSEMBLY, OPERATION, AND SAFETY INSTRUCTIONS CAREFULLY. AT LEAST TWO ADULTS ARE NEEDED TO PUT THIS GAME TABLE TOGETHER.**

# HARDWARE IDENTIFIER

## (Not to Scale)

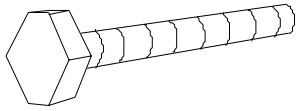

H1 - 10 x 115mm Bolt (8)

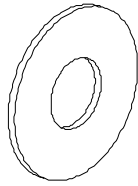

H2 - 10 x 25mm Washer (32)

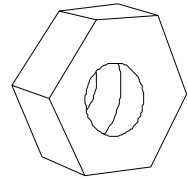

H3 - 10mm Hex Nut (16)

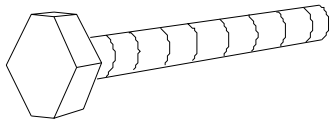

H4 - 10 x 180mm Bolt (8)

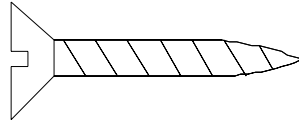

H5 - #8 x 1-1/4 Screw (4)

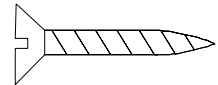

H6 - #12 Screw (12)

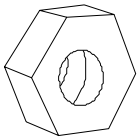

H7 - 1/4 Hex Nut (4)



H8 - 1/4 x 32mm Washer (4)

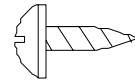

H9 - 1/2 Round Head Screw (24)

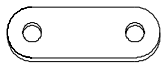

H10 - Locker (4)

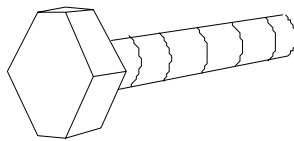

H11 - 5/16 x 1-3/4 Bolt (30)



H12 - 5/16 x 35mm Washer (18)

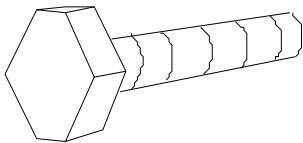

H13 - 1/4 x 1-3/4 Bolt (8)

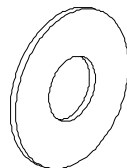

H14 - 1/4 x 19mm Washer (8)

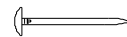

H15 - Nail (26)

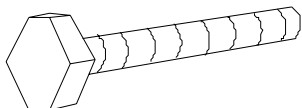

H16 - 12 x 140mm Bolt (4)

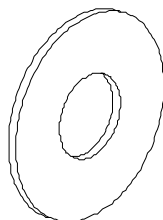

H17 - 13 x 28mm Washer (4)



H18 - 5/16 x 19mm Washer (12)

# PARTS IDENTIFIER

(Not to Scale)

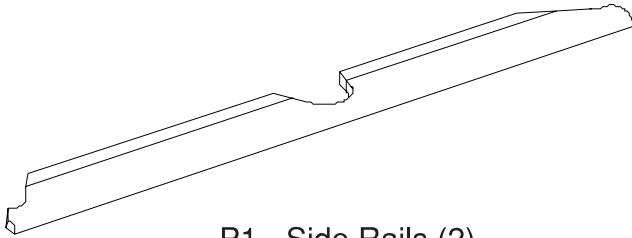

P1 - Side Rails (2)

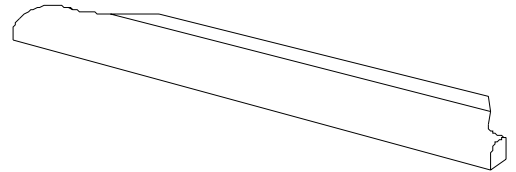

P2 - End Rails (2)

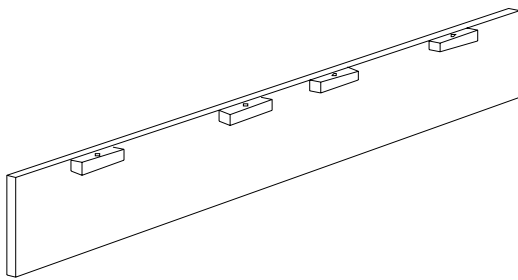

P3 - Side Apron (2)

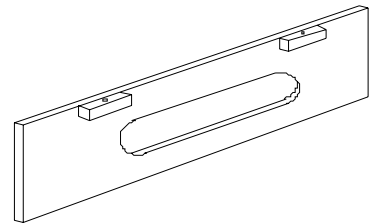

P4 - End Apron Ball Storage (1)

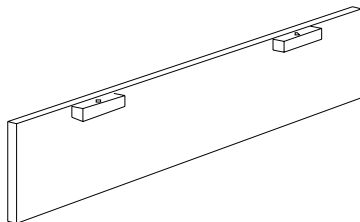

P5 - End Apron (1)

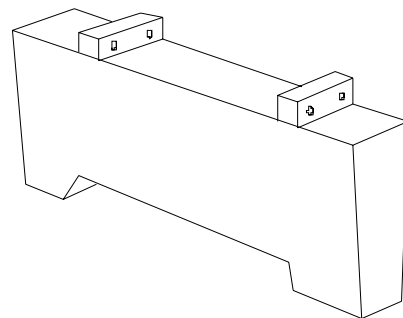

P6 - Leg Assembly (2)

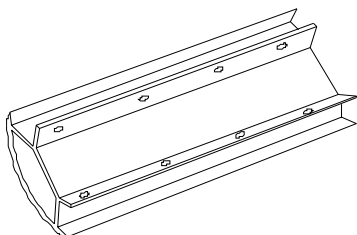

P7 - Corner Post (4)

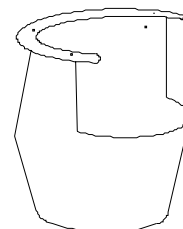

P8 - Pockets (6)

# PARTS IDENTIFIER

(Not to Scale)

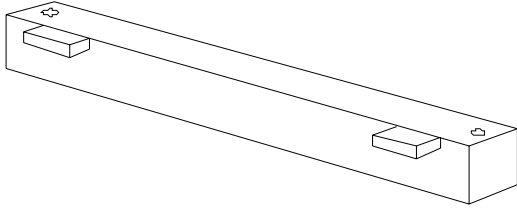

P9 - End Slat (2)

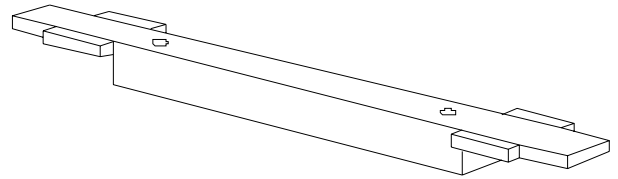

P10 - Center Slat (2)

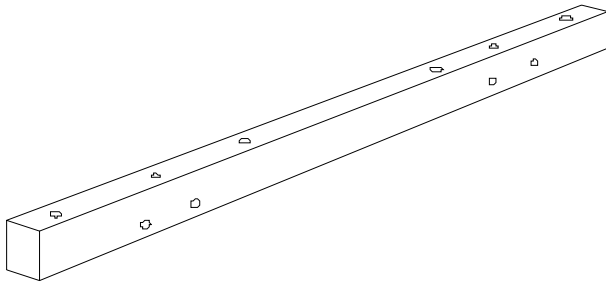

P11 - Beams (2)

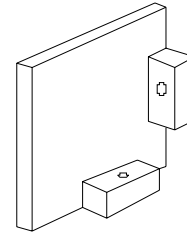

P12 - Ball Storage Panel A (2)

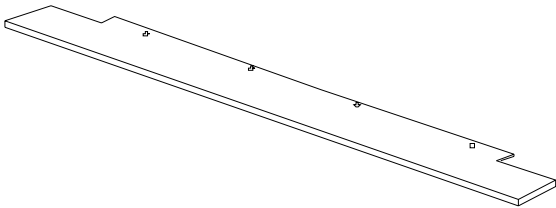

P13 - Ball Storage Panel B (1)

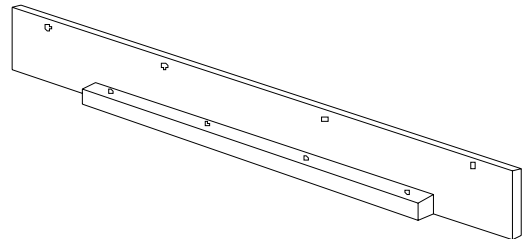

P14 - Ball Storage Panel C (1)

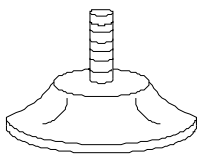

P15 - Leg Leveler (4)

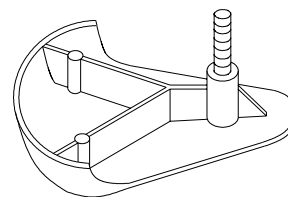

P16 - Corner Cap (4)

1. Find a clean, level place to begin the assembly of your pool table. It is best to assemble the table in its final resting place.
2. Screw the leg levelers into the bottom of each leg assembly. Then assemble the table frame as shown in the figure below.

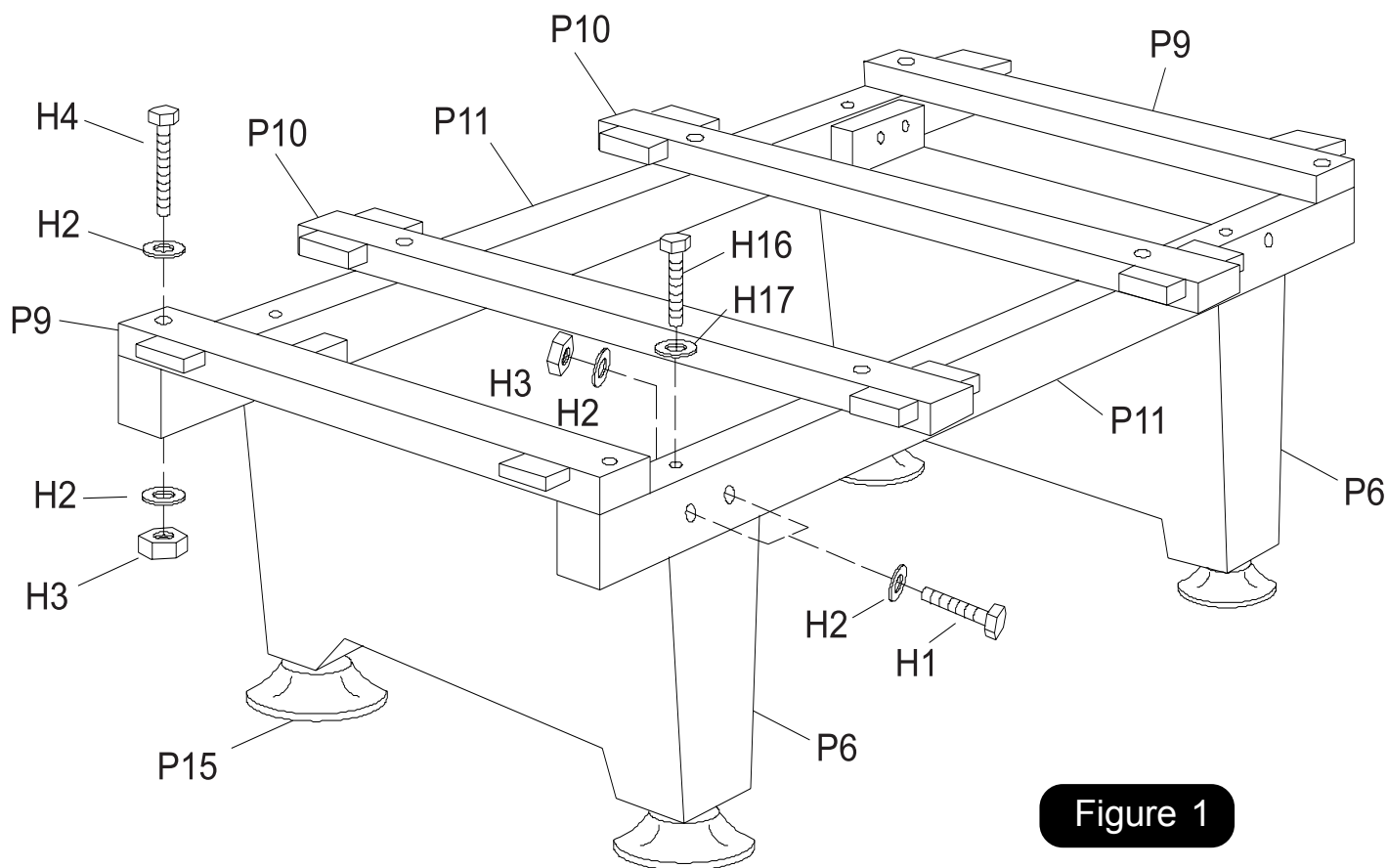
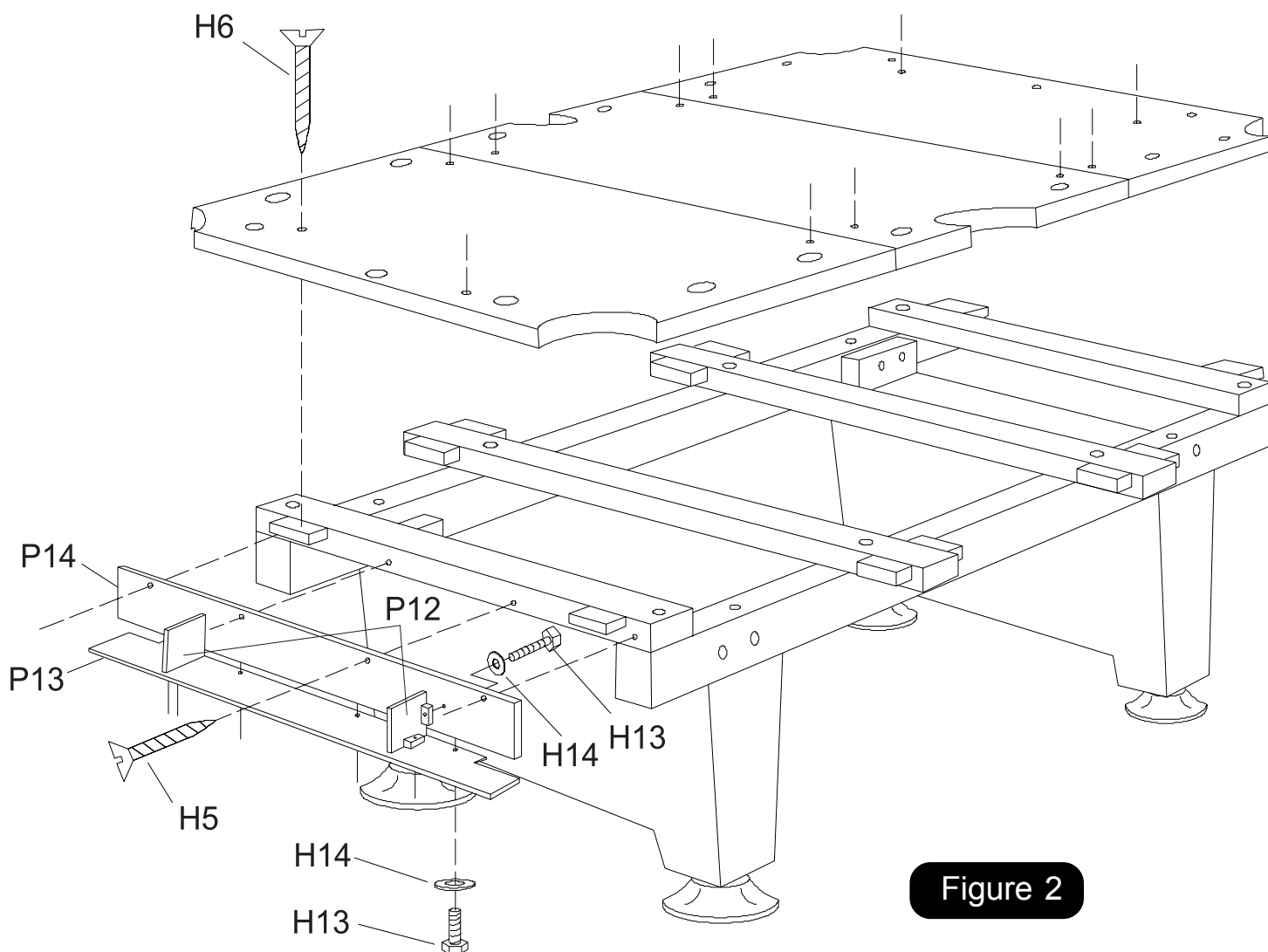

Figure 1

3. Assemble the ball storage panels P12, P13, and P14 together as shown in the figure below.
4. Attach the ball storage assembly to the frame as shown.
5. Install and level the slate using wood screws H6.
6. Cloth the bed and attach with glue, staples or tacks.  
(See instructions inside the cloth kit)



**Figure 2**

7. Assemble the rails P1 and P2 together as shown in the figure below.
8. Assemble the aprons P3 and P4 together with the corners posts P7 as shown below.
9. Attach the apron assembly to the rail assembly.

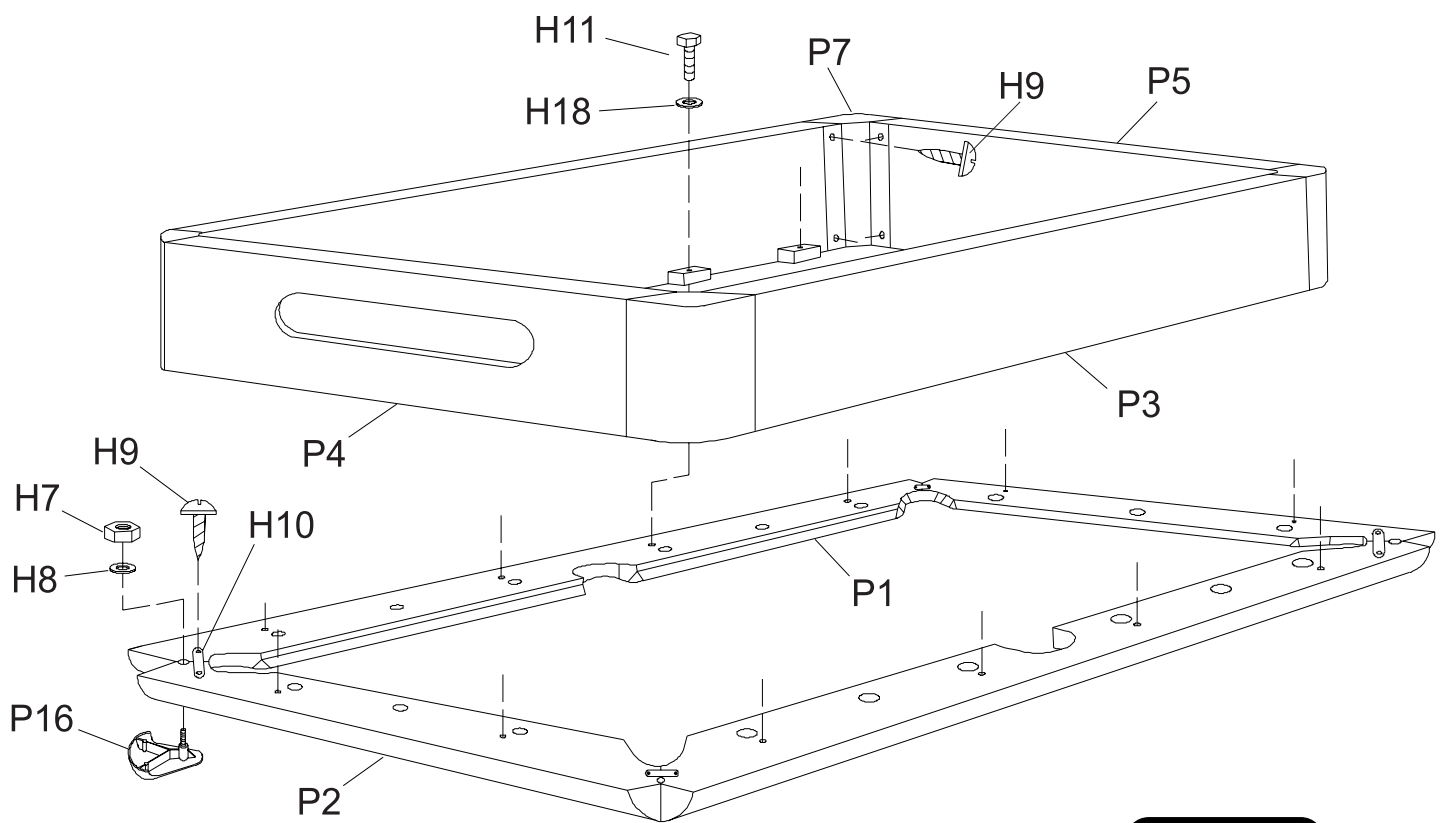

**Figure 3**

10. Attach the rail and apron assembly to the slate as shown below.

11. Slide the pockets in and secure with nails.

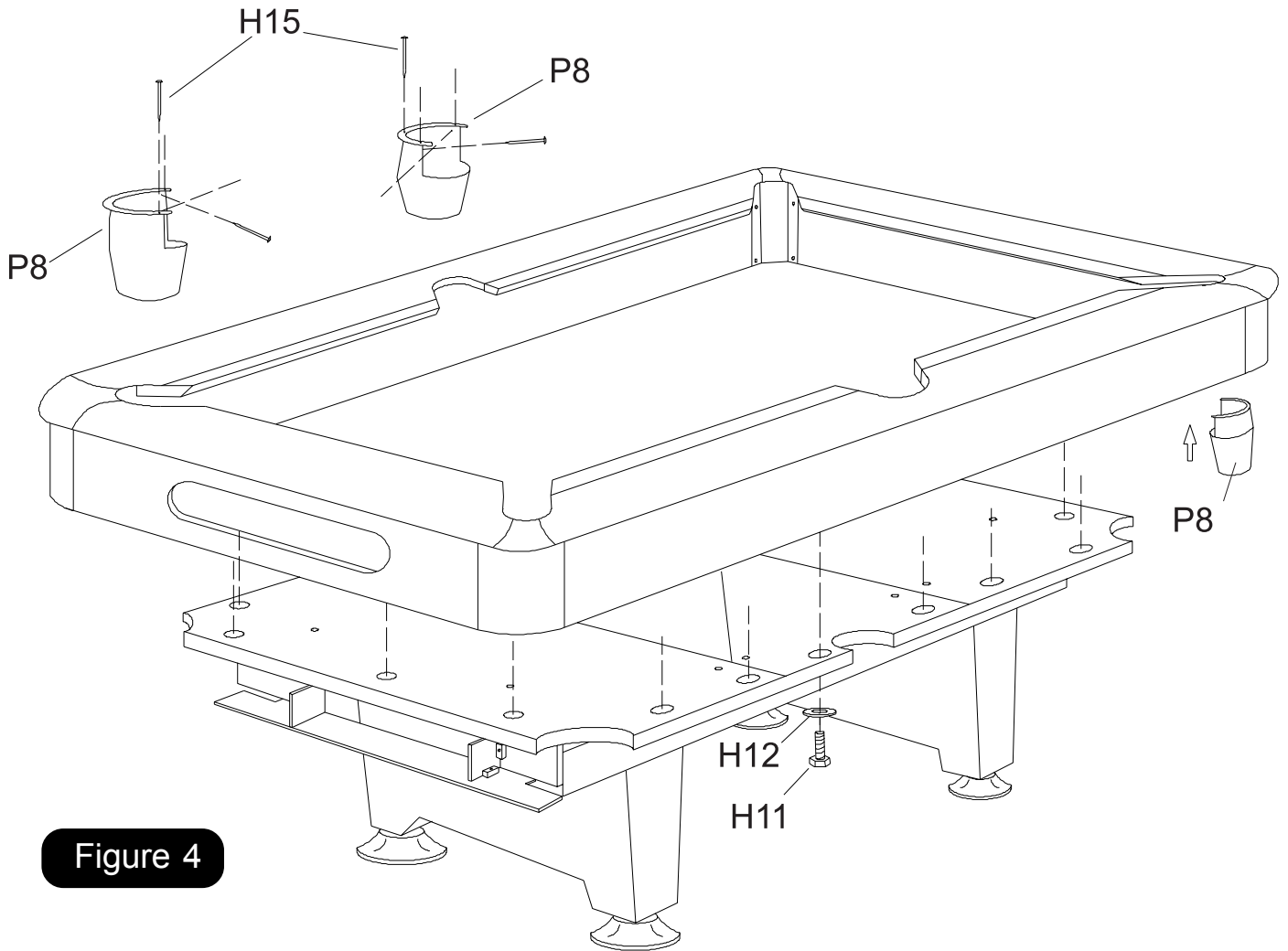

**Figure 4**

12. The rail cushion nose to nose dimension should measure 44 inches by 88 inches or as close as possible.

**NOTE: Look along the nose rubber of the side rails to be sure they align.**

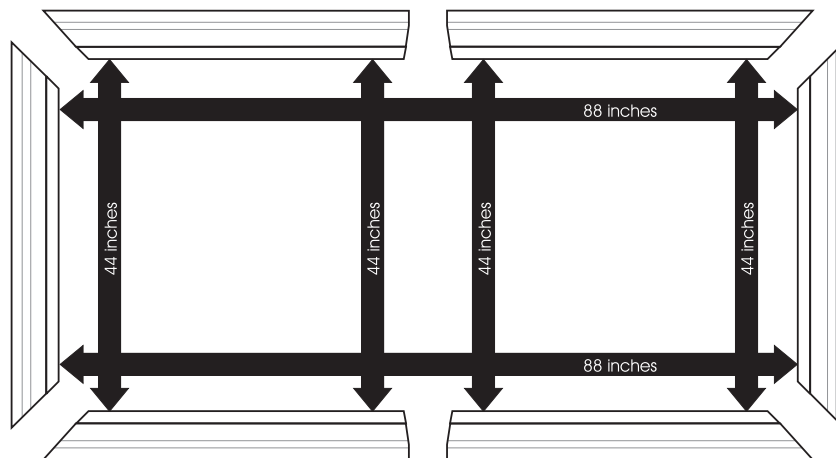

Congratulations! You have now assembled your pool table. Please note the Care and Use instructions below to insure many years of trouble free use of your game table.

## **CARE AND USE OF YOUR TABLE**

1. Use spray furniture polish to clean all exterior surfaces of your pool table.
2. You may use a vacuum cleaner with the brush attachment to clean the cloth should it become necessary.
3. This product is intended for **INDOOR** use only.
4. **DO NOT** sit, climb, or lean on the table.
5. **DO NOT** move the table while assembled. You will ruin the integrity of the table.
6. Disassemble the table if it needs to be moved.
7. If you have your table on carpet you may need to re-level it after it settles. This is normal.

## 8 - BALL

Eight-Ball is a call shot game played with a cue ball and 15 object balls, numbered 1 through 15. One player must pocket balls of the group numbered 1 through 7 (*solid colors*), while the other player has 9 through 15 (*stripes*). **The player pocketing either group first, and then legally pocketing the 8-ball wins the game.**

**CALL SHOT** In Call Shot, obvious balls and pockets do not have to be indicated. It

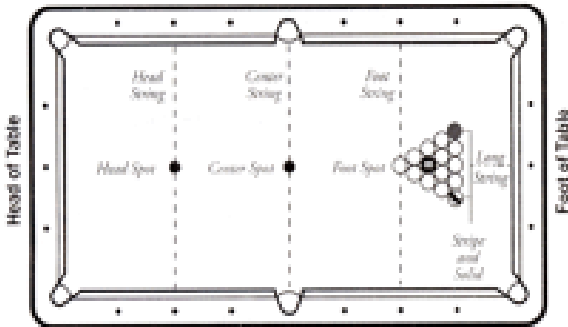

Diagram 20

is the opponent's right to ask which ball and pocket if he is unsure of the shot. Bank shots and combination shots are not considered obvious, and care should be taken in calling both the object ball and the intended pocket. When calling the shot, it is never necessary to indicate details such as the number of cushions, banks, kisses, caroms, etc. Any balls pocketed on a foul remain pocketed, regardless of whether they belong to the shooter or the opponent. The opening break is not a "called shot." Any player performing a break shot in 8-Ball may continue to shoot so long as any object ball is legally pocketed on the break.

### RACKING THE BALLS

The balls are racked in a triangle at the foot of the table with the 8-ball in the center of the triangle, the first ball of the rack on the foot spot, a stripe ball in one corner of the rack and a solid ball in the other corner.

### ALTERNATING BREAK

Winner of the lag has the option to break. During individual competition, players will alternate breaking on each subsequent game.

### JUMP AND MASSE SHOT FOUL

While "cue ball fouls only" is the rule of play when a match is not presided over by a referee, a player should be aware that it will be considered a cue ball foul if during an attempt to jump, curve or masse the cue ball over or around an impeding numbered ball that is not a legal object ball, the impeding ball moves (*regardless of whether it was moved by a hand, cue stick follow-through or bridge*).

### LEGAL BREAK SHOT

*(Defined)* To execute a legal break, the breaker (*with the cue ball behind the head string*) must either (1) pocket a ball, or (2) drive at least four numbered balls to the rail. When the breaker fails to make a legal break, it is a foul, and the incoming player has the option of (1) accepting the table in position and shooting, or (2) having the balls re-racked and having the option of shooting the opening break or allowing the offending player to re-break.

## SCRATCH ON A LEGAL BREAK

If a player scratches on a legal break shot, (1) all balls pocketed remain pocketed (*exception, the 8-ball: see rule "Object Balls Jumped Off Table On Break"*), (2) it is a foul, (3) the table is open.

**Please Note:** The incoming player has cue ball in hand behind the head string and may not shoot an object ball that is behind the head string, unless he first shoots the cue ball past the head string and causes the cue ball to come back behind the head string and hit the object ball.

## OBJECT BALLS JUMPED OFF TABLE ON THE BREAK

If a player jumps an object ball off the table on the break shot, it is a foul and the incoming player has the option of (1) accepting the table in position and shooting, or (2) taking cue ball in hand behind the head string and shooting.

## 8-BALL POCKETED ON THE BREAK

If the 8-ball is pocketed on the break, breaker may ask for a re-rack or have the 8-ball spotted and continue shooting. If the breaker scratches while pocketing the 8-ball on the break, the incoming player has the option of a re-rack or having the 8-ball spotted and begin shooting with ball in hand behind the head string.

## OPEN TABLE

*(Defined)* The table is "open" when the choice of groups (*stripes or solids*) has not yet been determined. When the table is open, it is legal to hit a solid first to make a stripe or vice-versa. **Note:** The table is always open immediately after the break shot. When the table is open it is legal to hit any solid or stripe or the 8-ball first in the process of pocketing the called stripe or solid. However, when the table is open and the 8-ball is the first ball contacted, no stripe or solid may be scored in favor of the shooter. The shooter loses his turn; any balls pocketed remain pocketed; and the incoming player addresses the balls with the table still open. On an open table, all illegally pocketed balls remain pocketed.

## CHOICE OF GROUP

The choice of stripes or solids is not determined on the break even if balls are made from only one or both groups, because the table is always open immediately after the break shot. The choice of group is determined only when a player legally pockets a called object ball after the break shot.

## LEGAL SHOT

*(Defined)* On all shots (*except on the break and when the table is open*), the shooter must hit one of his group of balls first and (1) pocket a numbered ball, or (2) cause the cue ball or any numbered ball to contact a rail. **Please Note:** It is permissible for the shooter to bank the cue ball off a rail before contacting the object ball; however, after contact with the object ball, an object ball must be pocketed, or the cue ball or any numbered ball must contact a rail. Failure to meet these requirements is a foul.

## "SAFETY" SHOT

For tactical reasons, a player may choose to pocket an obvious object ball and also discontinue a turn at the table by declaring "safety" in advance. A safety shot is defined as a legal shot. If the shooting player intends to play safe by pocketing an obvious object ball, then prior to the shot, the shooter must declare a "safety" to the opponent. If this is **not** done, and one of the shooter's object balls is pocketed, the shooter will be required to shoot again. Any ball pocketed on a safety shot remains pocketed.

## SCORING

A player is entitled to continue shooting until failing to legally pocket a ball of his group. After a player has legally pocketed all of his group of balls, he shoots to pocket the 8-ball.

## FOUL PENALTY

Opposing player gets cue ball in hand. This means that the player can place the cue ball anywhere on the table (*does not have to be behind the head string except on opening break*). This rule prevents a player from making intentional fouls which would put an opponent at a disadvantage. With "cue ball in hand," the player may use a hand or any part of a cue (*including the tip*) to position the cue ball. When placing the cue ball in position, any forward stroke motion contacting the cue ball will be a foul, if not a legal shot.

## COMBINATION SHOTS

Combination shots are allowed; however, the 8-ball can't be used as a first ball in the combination except when the table is open.

## ILLEGALLY POCKETED BALLS

An object ball is considered to be illegally pocketed when (1) that object ball is pocketed on the same shot a foul is committed, or (2) the called ball did not go in the designated pocket, or (3) a safety is called prior to the shot. Illegally pocketed balls remain pocketed.

## OBJECT BALLS JUMPED OFF THE TABLE

If any object ball is jumped off the table, it is a foul and loss of turn, unless it is the 8-ball, which is a loss of game. Any jumped object balls are spotted in numerical order according to General Rules for spotting balls.

## PLAYING THE 8-BALL

When shooting at the 8-ball, a scratch or foul is not loss of game if the 8-ball is not pocketed or jumped from the table. Incoming player has cue ball in hand. **Note:** A combination shot can never be used to legally pocket the 8-ball.

## LOSS OF GAME

A player loses the game by committing any of the following infractions:

1. Fouls when pocketing the 8-ball (*exception: see 8-Ball Pocketed On The Break*).
2. Pockets the 8-ball on the same stroke as the last of his group of balls.
3. Jumps the 8-ball off the table at any time.
4. Pockets the 8-ball in a pocket other than the one designated
5. Pockets the 8-ball when it is not the legal object ball.

**Note:** All infractions must be called before another shot is taken, or else it will be deemed that no infraction occurred.

## STALEMATED GAME

If, after 3 consecutive turns at the table by each player (*6 turns total*), the referee judges (*or if no referee, both players agree*) that attempting to pocket or move an object ball will result in loss of game, the balls will be re-racked with the original breaker of the stalemated game breaking again. The stalemate rule may only be used when there are only two object balls and the 8-ball remaining on the table. **Please Note:** Three consecutive fouls by one player is not a loss of game

## Diamond Shaped Rack

1-ball must be on the foot spot.  
9-ball must be in the center of the rack.

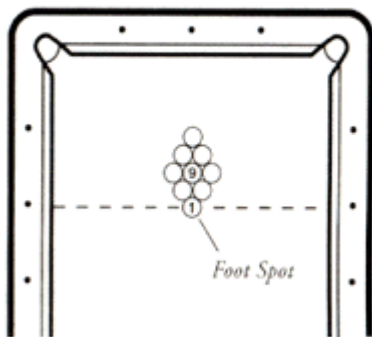

Diagram 21

## 9 - BALL

### OBJECT OF THE GAME

Nine-Ball is played with nine object balls numbered one through nine and a cue ball. On each shot, the first ball the cue ball contacts must be the lowest numbered ball on the table, but the balls need not be pocketed in order. If a player pockets any ball on a legal shot, he remains at the table for another shot, and continues until missing, committing a foul, or winning the game by pocketing the 9-ball. After a miss, the incoming player must shoot from the position left by the previous player, but after any foul the incoming player may start with the cue ball anywhere on the table. Players are not required to call any shot. A match ends when one of the players has won the required number of games.

### RACKING THE BALLS

The object balls are racked in a diamond shape, with the 1-ball at the top of the diamond and on the foot spot, the 9-ball in the center of the diamond, and the other balls in random order, racked as tightly possible. The game begins with cue ball in hand behind the head string.

### LEGAL BREAK SHOT

The rules governing the break shot are the same as for other shots except:

1. The breaker must strike the 1-ball first and either pocket a ball or drive at least four numbered balls to the rail.
2. If the cue ball is pocketed or driven off the table, or the requirements of the opening break are not met, it is a foul, and the incoming player has cue ball in hand anywhere on the table.
3. If on the break shot, the breaker causes an object ball to jump off the table, it is a foul and the incoming player has cue ball in hand anywhere on Diagram 21 the table. The object ball is not re-spotted (*exception; if the object ball is the 9-ball, it is re-spotted*).

### CONTINUING PLAY

On the shot immediately following a legal break, the shooter may play a "push out." (See "Push Out"). If the breaker pockets one or more balls on a legal break, he continues to shoot until he misses, fouls, or wins the game. If the player misses or fouls, the other player begins an inning and shoots until missing, committing a foul, or winning. The game ends when the 9-ball is pocketed on a legal shot, or the game is forfeited for a serious infraction of the rules.

## **PUSH OUT**

The player who shoots the shot immediately after a legal break may play a push out in an attempt to move the cue ball into a better position for the option that follows. On a push out, the cue ball is not pocketed. An illegal push out is penalized according to the type of foul committed. After a player scratches on the break shot, the incoming player cannot play a push out.

## **FOULS**

When a player commits a foul, he must relinquish his run at the table and no balls pocketed on the foul shot are re-spotted (*exception; if a pocketed ball is the 9-ball, it is re-spotted*). The incoming player is awarded ball in hand; prior to his first shot he may place the cue ball anywhere on the table. If a player commits several fouls on one shot, they are counted as only one foul.

## **BAD HIT**

If the first object ball contacted by the cue ball is not the lowest numbered ball on the table, the shot is foul.

## **NO RAIL**

If no object ball is pocketed, failure to drive the cue ball or any numbered ball to a rail after the cue ball contacts the object ball on is a foul.

## **IN HAND**

When the cue ball is in hand, the player may place the cue ball anywhere on the bed of the table, except in contact with an object ball. The player may continue to adjust the position of the cue ball until shooting.

## **OBJECT BALLS JUMPED OFF THE TABLE**

An un-pocketed ball is considered to be driven off the table if it comes to rest other than on the bed of the table. It is a foul to drive an object ball off the table. The jumped object ball(s) is not re-spotted ( *exception: if the object ball is the 9-ball it is re-spotted*) and play continues.

## **JUMP AND MASSE SHOT FOUL**

If a match is not refereed, it will be considered a cue ball foul if during an attempt to jump, curve or masse the cue ball over or around an impeding numbered ball, the impeding ball moves (regardless of whether it was moved by a hand; cue stick follow-through or bridge).

## **THREE CONSECUTIVE FOULS**

If a player fouls three consecutive times on three successive shots without making an intervening legal shot, the game is lost. The three fouls must occur in one game. The warning must be given between the second and third fouls. A player's inning begins when it is legal to take a shot and ends at the end of a shot on which he misses, fouls or wins, or when he fouls between shots.

## **END OF GAME**

A game starts as soon as the cue ball crosses over the head string on the opening break. The 1-ball must be legally contacted on the break shot. The game ends at the end of a legal shot which pockets the 9-ball, or when a player forfeits the game as the result of a foul

# PRODUCT PARTS LIST

P3236

Part #	Description	Qty	Part #	Description	Qty
H1	10 x 115mm Bolt	8	P1	Side Rails	2
H2	10 x 25mm Washer	32	P2	End Rails	2
H3	10mm Hex Nut	16	P3	Side Apron	2
H4	10 x 180mm Bolt	8	P4	End Apron Ball Storage	1
H5	#8 x 1-1/4 Screw	4	P5	End Apron	1
H6	#12 Screw	12	P6	Leg Assembly	2
H7	1/4 Hex Nut	4	P7	Corner Posts	4
H8	1/4 x 32mm Washer	4	P8	Pockets	6
H9	1/2" Round Head Screw	24	P9	End Slat	2
H10	Locker	4	P10	Center Slat	2
H11	5/16 x 1-3/4 Bolt	30	P11	Beam	2
H12	5/16 x 35mm Washer	18	P12	Ball Storage Panel A	2
H13	1/4 x 1-3/4 Bolt	8	P13	Ball Storage Panel B	1
H14	1/4 x 19mm Washer	8	P14	Ball Storage Panel C	1
H15	Nail	26	P15	Leg Leveler	4
H16	12 x 140mm Bolt	4	P16	Corner Cap	4
H17	13 x 28mm Washer	4	C1	Feather Strips	6
H18	5/16 x 19mm Washer	12	C2	Hardware Kit	1
			C3	Owners Manual	1

PLEASE RETAIN THIS MANUAL FOR FUTURE REFERENCE.

Rev01

# MURREY PRODUCTS ONE YEAR LIMITED WARRANTY

**WARRANTY DURATION:** This Murrey Pool table is warranted to the original consumer purchase for a period of 1 year against workmanship defects in the cabinet. It also warrants a period of 90 days against workmanship defects in the cloth, rubber and pockets from the original purchase.

**WARRANTY COVERAGE:** ESCALADE SPORTS warrants to the original Consumer Purchaser that any Product of its manufacture is free from defects in material and workmanship when used for the intended purpose under normal use and conditions.

THIS WARRANTY IS VOID IF THE PRODUCT HAS BEEN DAMAGED BY ACCIDENT, UNREASONABLE USE, NEGLIGENCE, IMPROPER SERVICE, FAILURE TO FOLLOW INSTRUCTIONS PROVIDED WITH THE PRODUCT OR OTHER CAUSES NOT ARISING OUT OF DEFECTS IN MATERIAL AND WORKMANSHIP.

**WARRANTY PERFORMANCE:** During the above warranty period, ESCALADE SPORTS shall repair or replace with a comparable model, and/or product, or component thereof, for any product which may prove defective under normal use, proper care and which our examination shall disclose to our satisfaction to be thus defective, please contact our Warranty Dept.

**1-866-556-2757 / Warranty Dept.**

Or Write us at:

**Escalade® Sports, Inc. - P. O. Box 889, Evansville, IN 47706 - Attn: Warranty Dept.**

Or E-mail us at:

**pooltables@escaladesports.com**

Other than shipping requirements no charge will be made for such repair or replacement of in-warranty Products. ESCALADE® SPORTS strongly recommends that the Product is insured for value prior to mailing.

## **WARRANTY ON SLATE SURFACE**

Manufacturer warrants for ten (10) years, Escalade Sports will repair the playing surface of this table, free of charge, if it fails to remain flat, within a tolerance of + or - 30/1000 of an inch, measuring from any flat plane within the playing surface. **NOTE:** Cloth not included in warranty. Should this product become defective due to material or workmanship within period, contact the Customer Service Department. This warranty is not transferable and does not cover normal wear and tear, or damage caused by improper handling, installation or use of this product. This warranty is also void if product is in any way abused, damaged, or modified from its original state, or if used for other than indoor residential use. This warranty gives the consumer specific legal rights, and may have other rights which may vary from state to state.

**WARRANTY DISCLAIMERS:** ANY IMPLIED WARRANTIES ARISING OUT OF THIS SALE, INCLUDING BUT NOT LIMITED TO THE IMPLIED WARRANTIES OF MERCHANTABILITY AND FITNESS FOR A PARTICULAR PURPOSE, ARE LIMITED IN DURATION TO THE ABOVE WARRANTY PERIOD. ESCALADE® SPORTS SHALL NOT BE LIABLE FOR LOSS OF USE OF THE PRODUCT OR OTHER CONSEQUENTIAL OR INCIDENTAL COSTS, EXPENSES OR DAMAGES INCURRED BY THE CONSUMER OF ANY OTHER USE.

Some states do not allow the exclusion or limitation of implied warranties or consequential or incidental damages, so the above limitations or exclusions may not apply to you.

**LEGAL REMEDIES:** This warranty gives you specific legal rights and you may also have other rights, which may vary, from state to state.

**ESCALADE**  
SPORTS

Mailing Address:

**Escalade Sports  
P O Box 889  
Evansville, IN 47706**

**Phone: 1-866-556-2757** (Toll Free)

**Fax: 1-866-873-3532** (Toll Free)

**E-mail: pooltables@escaladesports.com**

**www.escaladesports.com**

**www.billiardtables.com**