

ASSEMBLY INSTRUCTIONS AND RULES

MODEL G01100

 HARVARD®

**CLASSIC
JUNIOR
SOCCER
TABLE**

TABLE SOCCER

Thank you for buying our product. We strive to ensure that our products are of the highest quality and free of manufacturing defects or missing parts. However, if you have any problems with your new product, ***please do not return it to the store.*** Call us at:

1 - 800 - 426 - 1421

(THIS IS A CONSUMER ONLY NUMBER)

FAX: 812-467-1399

OR WRITE TO:
ESCALADE SPORTS
CUSTOMER SERVICE DEPARTMENT
P.O. BOX 889
EVANSVILLE, IN 47706

When contacting Escalade Sports please provide model number, serial number (if applicable), and part number if requesting a replacement part. These numbers can be found on the product, packaging, and in this Owner's Manual.

REQUIRED TOOLS

PHILLIPS SCREWDRIVER

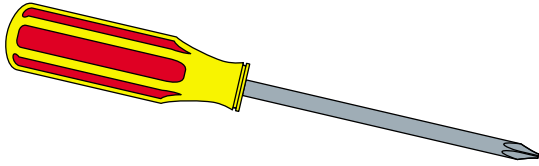

STANDARD SCREWDRIVER

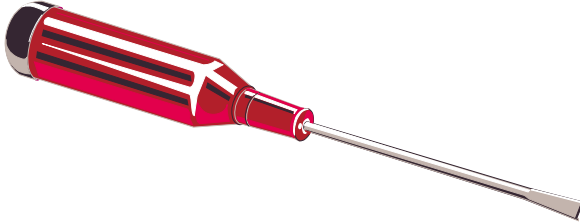



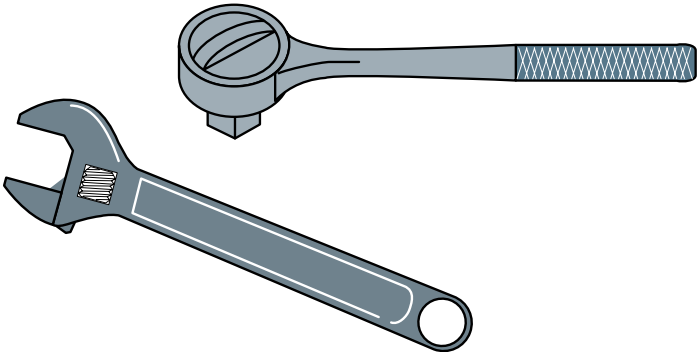

ADJUSTABLE WRENCH
OR STANDARD SOCKET SET

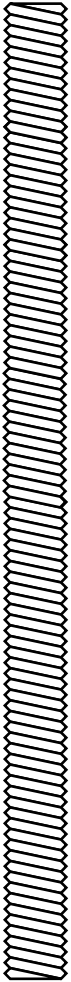

PARTS IDENTIFIER

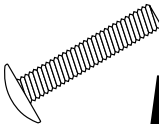
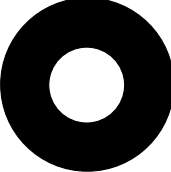
HARDWARE (ACTUAL SIZE MAY VARY)

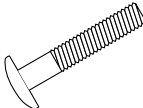

	DESCRIPTION	QTY. REQUIRED (EXTRA PIECES MAY BE INCLUDED)
	H1 5/16" X 1 1/4" BOLT	8
	H2 5/16" WASHER, BLACK FLAT	24
	H3 1/4" X 24 7/8" ROD	2
	H4 1/4" WASHER, FLAT	4
	H5 1/4" LOCK NUT	4
	H6 5/16" X 1 3/4" BOLT	16

H3



PARTS IDENTIFIER

ASSEMBLY PARTS

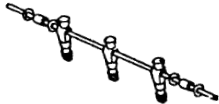
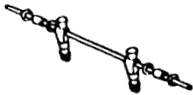

	DESCRIPTION	QTY
	P1 SIDE PANEL	2
	P2 END PANEL	2
	P3 PLAYING FIELD	1
	P4 RIGHT LEG	4
	P5 LEFT LEG	4
	P6 PLAYING FIELD SUPPORT BRACE	3
	P7 ROD HANDLE	8
	P8 ROD END CAP	8
	P9 BALL CATCHER	2
	H9 3/4" FLAT HEAD PHILLIPS SCREW	8
	P10 BALL EXPORT CUP	2
	P9 1/2" FLAT HEAD PHILLIPS SCREW	6

PARTS IDENTIFIER

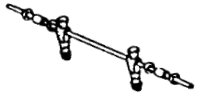
ASSEMBLY PARTS









	DESCRIPTION	QTY
	R1 4 YELLOW PLAYER ROD	1
	R2 3 YELLOW PLAYER ROD	2
	R3 2 YELLOW PLAYER ROD	1
	R4 4 BLUE PLAYER ROD	1
	R5 3 BLUE PLAYER ROD	2
	R6 2 BLUE PLAYER ROD	1

ACCESSORIES

	DESCRIPTION	QTY
	A1 SOCCER BALL	2
	A2 TOOL	1
	A3 TOOL	2

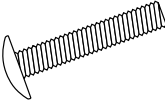
PARTS IDENTIFIER

PRE-ASSEMBLED PARTS

	DESCRIPTION	QTY
	C1 4 PLAYER ROD	2
	C2 3 PLAYER ROD	4
	C3 2 PLAYER ROD	2
	C4 ROD SPRING	16
	C5 ROD WASHERS	32
	C6 10-24 X 7/8" BOLT (used to install men)	26
	C7 10-24 LOCKING NUT (used to install men)	26
	C8 BLUE MEN	13
	C9 YELLOW MEN	13
	C10 ROD BUSHING	32

ASSEMBLY INSTRUCTIONS

SOCCER TABLE ASSEMBLY

WARNING: TWO ADULTS NEEDED TO ASSEMBLE SOCCER TABLE

IMPORTANT:

Please read through the instruction book before attempting assembly to familiarize yourself with all parts and assembly steps.

- 1.** CUT CORNERS OF THE BOX TOP AND PLACE IT ON THE FLOOR TO PROTECT THE PARTS AS THE UNIT IS BEING ASSEMBLED. PLACE SIDE PANELS **P1** UPSIDE DOWN WITH THE SLOT FACING INWARD AS SHOWN IN **figure 1A**. (BALL ENTRY HOLE WILL BE CLOSEST TO THE FLOOR.) TO EASE ASSEMBLY PUSH THE PRE-ASSEMBLED SPRINGS AND WASHERS ON THE RODS UP AGAINST THE MEN. AT THIS TIME DO NOT CUT THE RUBBER BANDS THAT HOLD THE ASSEMBLY TOGETHER. ALIGN THE RODS AS SHOWN IN **figure 1A**. THE HANDLE END OF THE RODS ARE THE ENDS WITH THE HOLES APPROX. 1/2" FROM THE END

REMEMBER:

You are working upside down. All of the yellow men must face one direction and the blue the other. All yellow men handles will go on one side; all the blue on the other. The handle ends are the ends with the holes approx. 1/2" from the end of the rod.

ASSEMBLY INSTRUCTIONS

SOCCER TABLE ASSEMBLY

WARNING: TWO ADULTS NEEDED TO ASSEMBLE SOCCER TABLE

2. INSERT THE RODS THROUGH THE ROD BUSHINGS IN THE SIDE PANEL AS SHOWN IN *figure 1A*.
3. SLIDE PLAY FIELD *P3* INTO THE GROOVES ON THE SIDE PANELS *P1* WITH GRAPHICS FACING DOWN. SEE *figure 1B*.

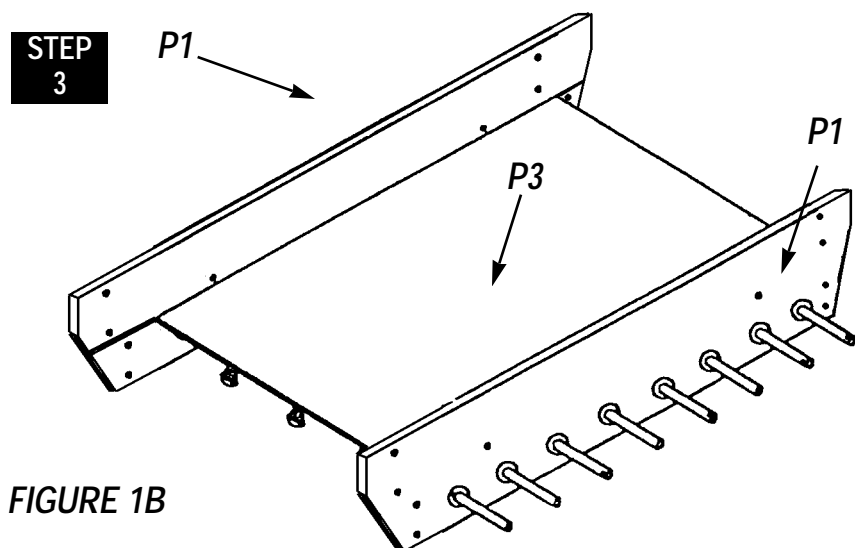
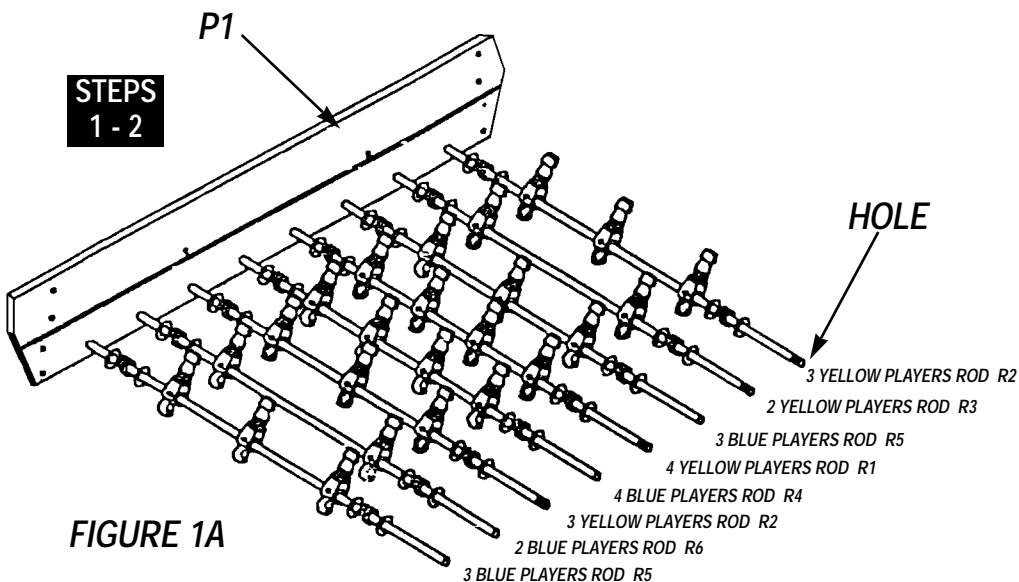

ASSEMBLY INSTRUCTIONS

SOCCER TABLE ASSEMBLY

WARNING: TWO ADULTS NEEDED TO ASSEMBLE SOCCER TABLE

- 4.** ATTACH THE TWO END PANELS **P2** TO THE SIDE PANELS **P1** AS SHOWN IN **figure 2**. REMEMBER THE GROOVE MUST FACE INWARD TOWARD THE PLAYFIELD. ATTACH THE END PANELS WITH BOLTS **H6** AND WASHERS **H2** INTO THE PRE-INSTALLED DOWEL CONNECTORS. TIGHTEN HARDWARE AT THIS TIME

CAUTION:

Do not over-tighten hardware!

- 5.** PLACE THE PLAYFIELD SUPPORTS **P6** ON THE BOTTOM OF THE PLAYFIELD. INSERT SUPPORT RODS **H3** THROUGH THE HOLES IN THE SIDE PANELS **P1** AND THE GROVE IN THE PLAYFIELD SUPPORTS **P6** AS SHOWN IN **figure 3**. PLACE WASHER **H4** AND LOCKNUT **H5** ON EACH END OF SUPPORT RODS **H3**.

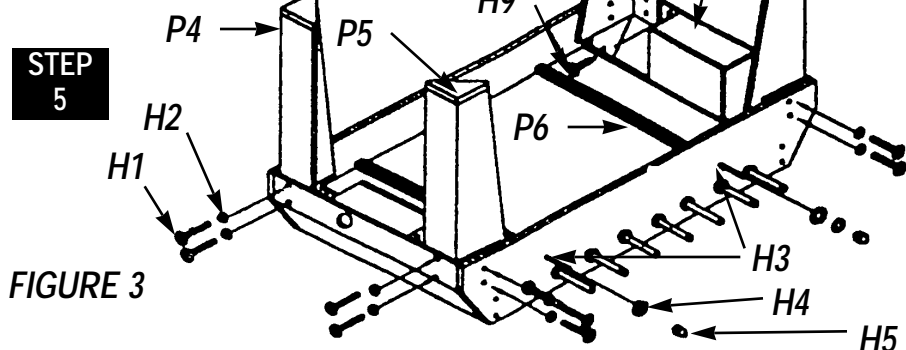
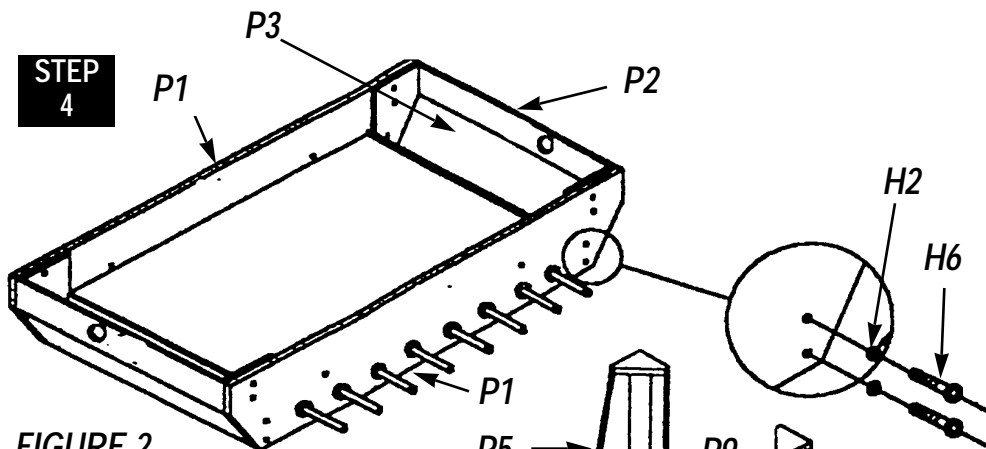

ASSEMBLY INSTRUCTIONS

SOCCER TABLE ASSEMBLY

WARNING: TWO ADULTS NEEDED TO ASSEMBLE SOCCER TABLE

- 6.** ATTACH THE LEGS AS SHOWN IN **figure 4**. THERE ARE TWO RIGHT LEGS **P4** AND TWO LEFT LEGS **P5**. THE WIDER SIDE OF THE LEG IS BOLTED TO THE SIDE PANELS **P1**. THE LEGS ARE ATTACHED WITH BOLTS **H1** AND WASHERS **H2**. THE THREADED T-NUTS ARE PRE-ASSEMBLED IN THE LEGS. TIGHTEN HARDWARE AT THIS TIME.

CAUTION:

Do not over-tighten hardware!

- 7.** INSTALL BALL CATCHERS **P9** UNDER TABLE AS SHOWN IN **STEP 6**. ATTACH THE BALL CATCHERS **P9** TO THE END PANELS **P2** USING SCREWS **H9** (3/4" FLAT HEAD PHILLIPS SCREW).

STEP
6 & 7

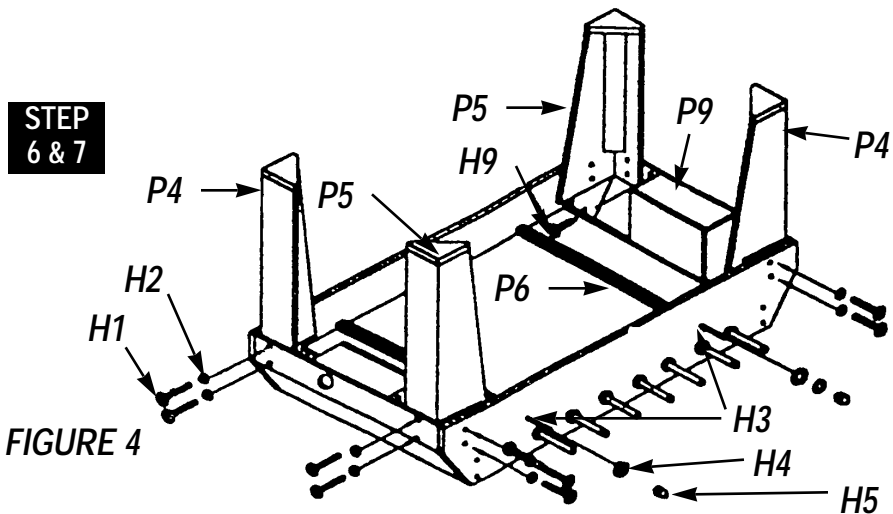

WARNING:

This step requires two adults!

Very carefully turn the table over and set on its legs.
Be careful. The table is very heavy and the rods will slide.
Do not lift the table by holding onto the rods.

ASSEMBLY INSTRUCTIONS

SOCCER TABLE ASSEMBLY

WARNING: TWO ADULTS NEEDED TO ASSEMBLE SOCCER TABLE

- ATTACH BALL RETURN CUP **P10** TO THE OUTSIDE OF THE END PANEL **P2** USING SCREWS **H10**. DO NOT OVER TIGHTEN! PUSH ON ROD HANDLES **P7** ON THE ROD ENDS WITH THE HOLES. PUT ROD CAPS **P8** ON OTHER END OF ROD.
- CAREFULLY CUT THE RUBBER BANDS THAT HOLD THE BUSHING ASSEMBLIES TOGETHER ON THE RODS.

HINTS:

If the rods do not slide freely you can spray furniture polish on a rag and wipe down the rods. This will make them slide easier. If the playfield has a slight warp you can loosen the nuts **H5** on the rods **H3** to help relax the playfield.

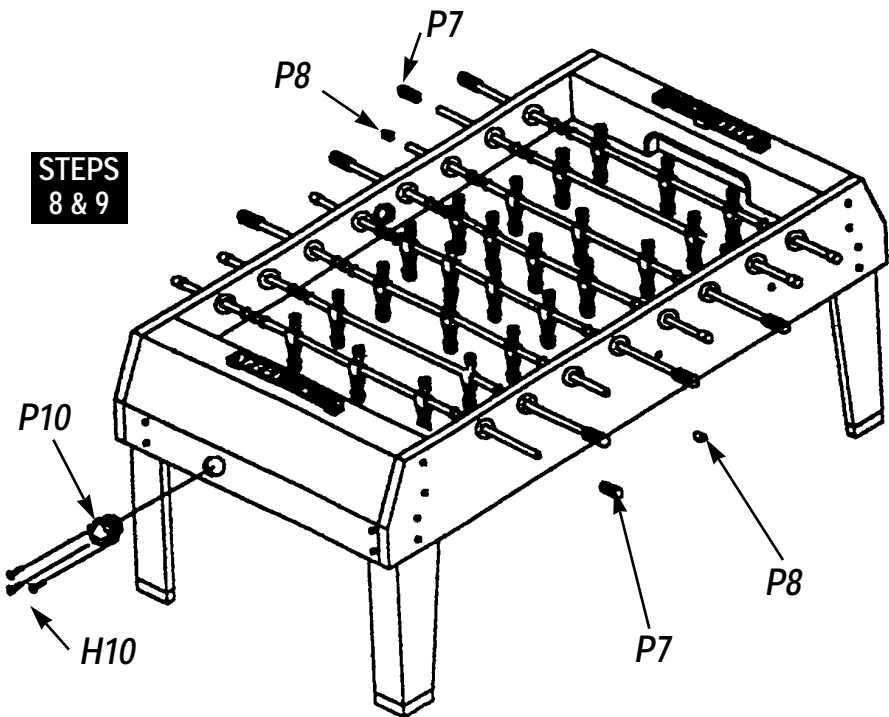

FIGURE 5

GAME RULES

TABLE SOCCER

Table soccer is also called "foosball." It can be played by two teams of four players each or by two individuals:

The Object of the Game:

To be the first team (or player) to score a predetermined number of points or to score the most points in given amount of time.

How To Play:

Serving:

The server rolls the ball through the serving hole to start the game, after a point is scored, or after a ball leaves the table. The server can spin the ball to influence the serve, but the ball must be struck by one of the serving team's (or server's) player figures. Once the ball is in play, it remains in play until it is hit off the table, a dead ball is declared, time out is called, or a point is scored.

Passing:

If a ball is pinned on the 5-man rod, it cannot be passed to the 3-man rod of the same team without touching at least two player figures as it is being passed.

Scoring:

When a ball enters the opposing team's goal, a point is scored. If the ball enters the goal, but bounces back onto the playing surface or leaves the table, it still counts as a goal.

Spinning Rods:

Spinning the rods is illegal.

Ball Off the Table:

If the ball leaves the playing surface and strikes any object that is not part of the table, it is declared "off the table" and should be put back into play by a serve from the team (or player) that originally served that ball. If the ball rolls into the serving cup and then returns to the playing surface, it is still considered "in play."

Dead Ball:

If a ball has completely stopped its motion and cannot be reached by any player figure, it is declared a "dead ball." If the ball is declared dead between the goal and the 2-man rod, it should be put back into play by placing it in nearest corner and releasing it. If the ball is declared dead anywhere else on the playing surface, it should be put back into play by a serve from the team that originally served the ball. If a ball is spinning in place, it is not considered a dead ball.

90 DAY WARRANTY

Manufacturer warrants to the original retail purchaser, this product to be free from defects in material and workmanship for a period of ninety (90) days from the date of purchase. Should this product become defective due to material or workmanship within the warranty period, contact our Customer Service Department. This warranty is not transferable and does not cover normal wear and tear, or damage caused by improper handling, installation, or use of this product. This warranty is also void if product is in any way abused, damaged, or modified from its original state, or if used for other than indoor residential use. This warranty gives you specific legal rights, and you may have other rights which vary from state to state.

PARTS LIST

(ALL PARTS SOLD AS INDIVIDUAL PIECES)

HARDWARE

DESCRIPTION	PART #	DESCRIPTION	PART #
5/16 x 1-1/4" bolt	01100-H1	1/4" lock nut	01100-H5
5/16" flat washer	01100-H2	3/16 x 1-3/4" bolt	01100-H6
1/4 x 24-7/8" Cabinet rod	01100-H3		
1/4" flat washer	01100-H4		
		3/4" flat head screw	01100-H9
		1/2" flat head screws	01100-H10

ASSEMBLY PARTS

DESCRIPTION	PART #	DESCRIPTION	PART#
Side panels	01100-P1	Rod Handles	01100-P7
End panels	01100-P2	Rod end caps	01100-P8
Playfield	01100-P3	Ball catcher	01100-P9
Right leg	01100-P4	Ball return cup	01100-P10
Left leg	01100-P5		
Playfield supports	01100-P6		

ACCESSORIES

DESCRIPTION	PART #
Soccer ball	01100-A1
Allen Wrench	01100-A2
Wrench	01100-A3

ROD ASSEMBLIES

DESCRIPTION	PART #	DESCRIPTION	PART #
Yellow 4 player	01100-R1	Blue 4 player	01100-R4
Yellow 3 player	01100-R2	Blue 3 player	01100-R5
Yellow 2 player	01100-R3	Blue 2 player	01100-R6

PRE-ASSEMBLED PARTS

DESCRIPTION	PART #	DESCRIPTION	PART #
4 player rod	01100-C1	10-24 x 7/8" bolt	01100-C6
3 player rod	01100-C2	10-24 locknut	01100-C7
2 player rod	01100-C3	Blue player	01100-C8
Rod springs	01100-C4	Yellow player	01100-C9
Rod washers	01100-C5	Rod bushing	01100-C10

ESCALADE[®]
S P O R T S
S E R I O U S P L A Y[®]

Consumer Hotline
1-800-426-1421

Fax: 1-812-467-1399

or write to:
Escalade Sports
Customer Service Department
P.O. Box 889
Evansville, IN 47706

Ask for our full line of exciting sports products
at a sporting goods retailer nearest you.

Table Tennis Tables
Pool Tables
Basketball
Dartboard Cabinets
Table Hockey Tables
Soccer Tables
Multi-Sport Tables

HARVARD

STIGA[®]

SPALDING[®]